



## The wall mounting enclosure solution for rough industrial use

# VARIindustry



Sample configuration

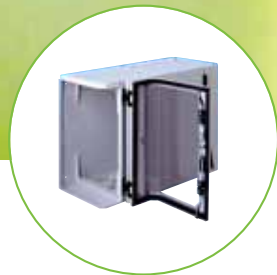

three-point lock



optimum accessibility from both sides



removable front cover



### VARI Industry

- Protection system: IP 54
- stylish enclosure
- space-saving design
- stable basic construction
- 2 doors with turning lever lock and three-point locking system
- one side with integrated plexiglass pane
- removable front cover
- doors with 180° hinges for optimum accessibility
- profile half-cylinder lock and double bit key, 5mm
- integrated cable flange plates
- installation dimensions in compliance with IEC 297-1
- integrated outlet filter (IP 54) for fan installation

This stylish enclosure is perfect when used as a compact switch cabinet or when used for network cabling in rough environments. The high IP 54 Protection system and the stable construction of the enclosure protect your equipment from external influences like dust, moisture and mechanical attacks.

Space saving installation is guaranteed due to the vertically arranged 19" mountings. The two doors in front and rear as well as the removable front cover ensure optimum accessibility. Upper and lower cable flange plates allow easy and safe cable entry.



## Specifications

### Application:

wall-mounting enclosure for tight spaces and unfavourable environmental conditions such as high humidity and dust

### Construction:

sturdy spot-welded and powder-coated sheet metal

### Finish:

RAL 7035 light grey

### Protection system:

IP 54

### Standards:

installation dimensions in compliance with IEC 297-1

### Delivery:

assembled

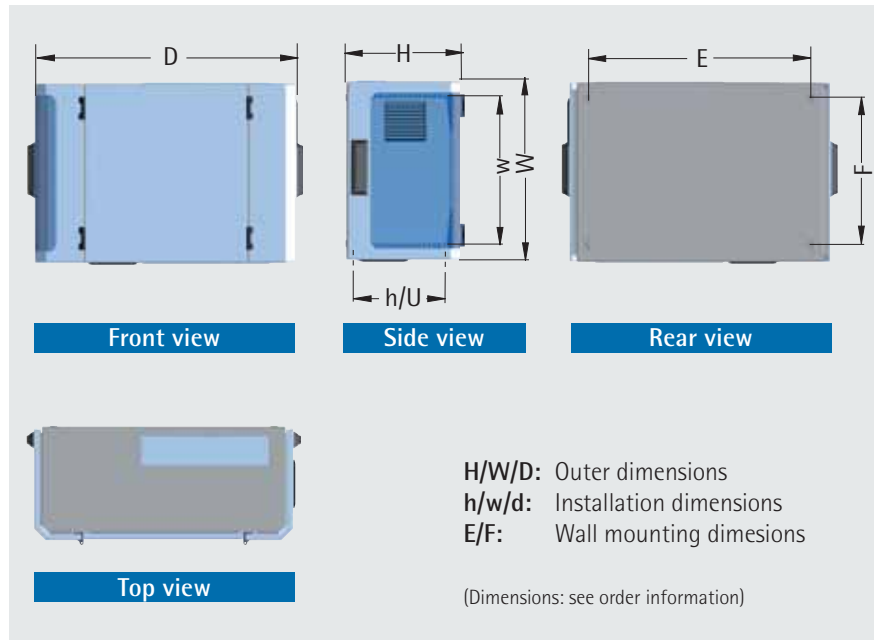

## Delivery

Item	Pc.	Description
1	1	Enclosure chassis
2	1	Door with plexiglas pane
3	1	Door with cutout for fans
4	1	Front cover, removable
5	2	Turning lever locks with 3-point locking system with double-bit mechanism (5 mm)
6	2	Cable flange plates
7	2	Outlet filter, IP 54, for 119 x 119mm fans
		Assembly material

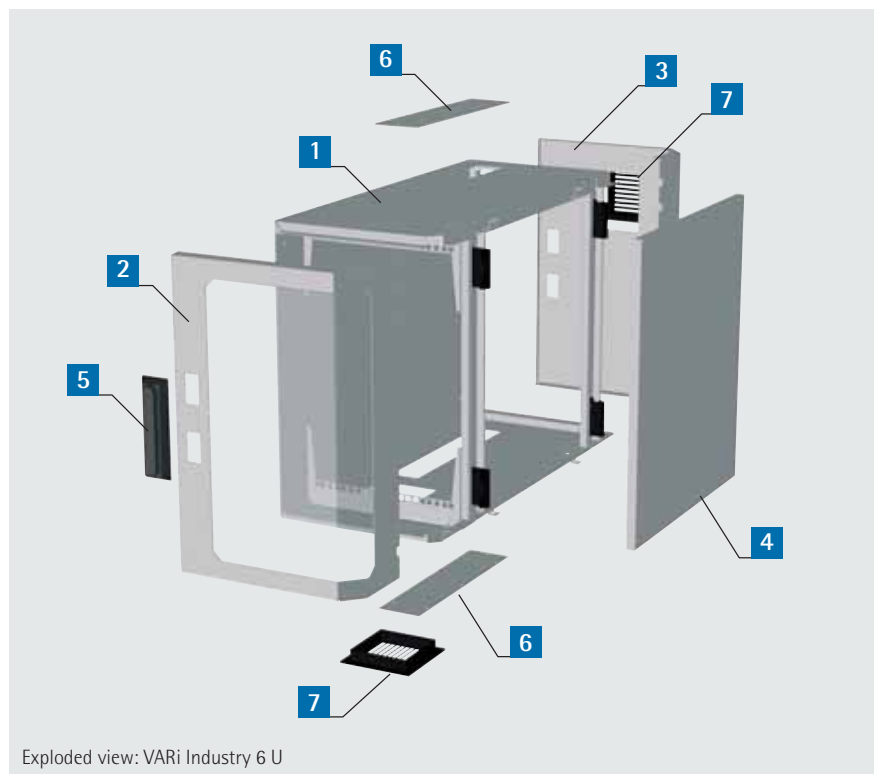

## Order information

Description	Outer dimensions (H x W x D) mm	Installation dimensions (h x w x d) mm	Wall-mounting dimensions (E x F) mm	Order no.
VARI Industry 4 U	275 x 560 x 840	177 x 449 x 650	680 x 450	306-040-00
VARI Industry 6 U	365 x 560 x 840	267 x 449 x 650	680 x 450	306-060-00



Sample configuration



### VARI Industry "cool-box" 6 U

- air-conditioned wall-mounting enclosure for industrial environment
- 380 W cooling unit can be assembled on the removable front cover

**Dimensions (H x W x D):**  
522 mm x 560 mm x 840 mm

**Finish:**  
RAL 7035 light grey

**Protection system:**  
IP 54

**Delivery:**  
prepared for mounting of cooling unit  
(cooling unit is included in delivery)

<b>Order no.</b>
306-060-20

### Accessories VARI Industry and VARI Industry "Cool-box"

#### Velcro® strip



- for quick fixation of **non-19" components**
- Length: 400 mm

<b>Order no.</b>
671-122-04

#### Fan set

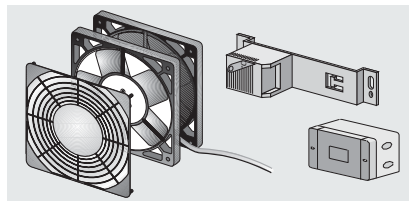

- Fan set consists of:
- fan, 230V, 160m<sup>3</sup>/h, 41dB(A)
  - fan guard
  - outlet
  - thermostat, 0-60°C
  - assembly material included

<b>Order no.</b>
306-060-15

#### Mounting plate

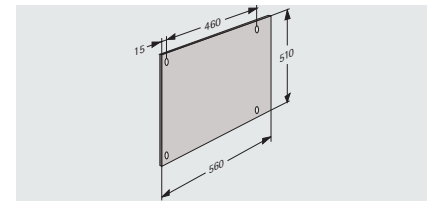

- for mounting of heavy components
- assembly material included

**Finish:** galvanised

<b>Order no.</b>
306-060-70

#### Screw set M 5 / M 6 (50-fold)

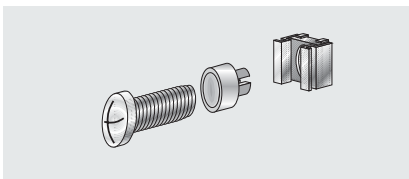

Description	Order no. (set)
M 5	630-991
M 6	630-994

#### Earthing kit

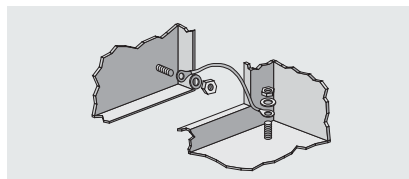

- allows the earthing of enclosure components in compliance with VDE

<b>Order no. (set)</b>
306-060-50

#### Profile half-cylinder

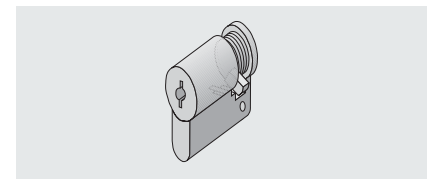

- for retrofitting standard doors into lockable doors with keys
- 2 keys included

<b>Order no.</b>
676-062