



An enclosure with individual profile

Tamago!



excellent features



click!

apra-lock locking system

The "apra-lock" patented locking system allows you to access your built-in components quickly without using tools.



Stylish design

The enclosure price winner at the Rhineland-Palatinate award for design and function.

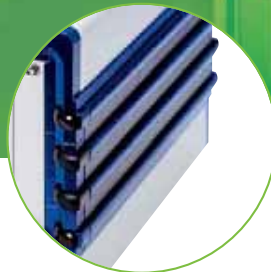

Trim pieces

You can customise your enclosure's design by clipping trim pieces onto the sides. Trim pieces in different colours are available on request.

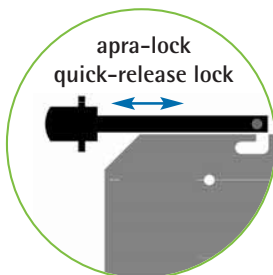

apra-lock
quick-release lock

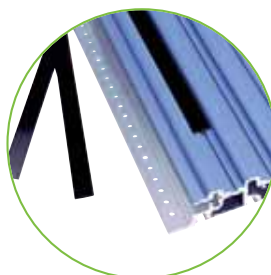

19" enclosure system *Tamago*

- future-oriented design
- handle bar can be integrated
- easy handling
- patented "apra-lock" locking system
- clip-on trim pieces for custom design
- diverse accessories (e.g., prop-up and carrying handle, sliding rails)
- also available as a desktop enclosure (see chapter 2 "desktop enclosure systems" page 35)



Specifications

Application:

19" plug-in units, shelves and 19" subracks can be installed in the enclosure.

Construction:

Stylish aluminium extrusions and zinc die-cast parts form the stable basic structure of this enclosure system. The top and bottom shells as well as rear panels are made of aluminium and are available in ventilated or non-ventilated versions.

Finish:

Frame and side extrusion:

RAL 7001 silver grey

Vertical mountings:

clear chromated

Top/bottom shell:

RAL 7035 light grey

Locks and decorative knobs:

RAL 9005 deep black

Material:

Frame: zinc die-cast/aluminium extrusion

Side panels: aluminium extrusions

Top/bottom shell:

aluminium panel, 1.5mm

Locks: die-cast zinc

Decorative knobs: plastic

Feet: rubber/plastic

Protection system:

IP 40: solid

IP 20: ventilated

Standards:

Installation dimensions acc. IEC 297-1

Delivery:

partially assembled,
assembly instruction included

Included in delivery

Item	Pc.	Description
1	2	Side panels
2	2	Frames front and rear
3	4	Vertical mountings
4	1	Top panel, solid
5	1	Bottom panel, solid
6	8	Locks
7	8/20/32	Decorative knobs
8	4	Feet, non-skidding
9	1	Assembly set

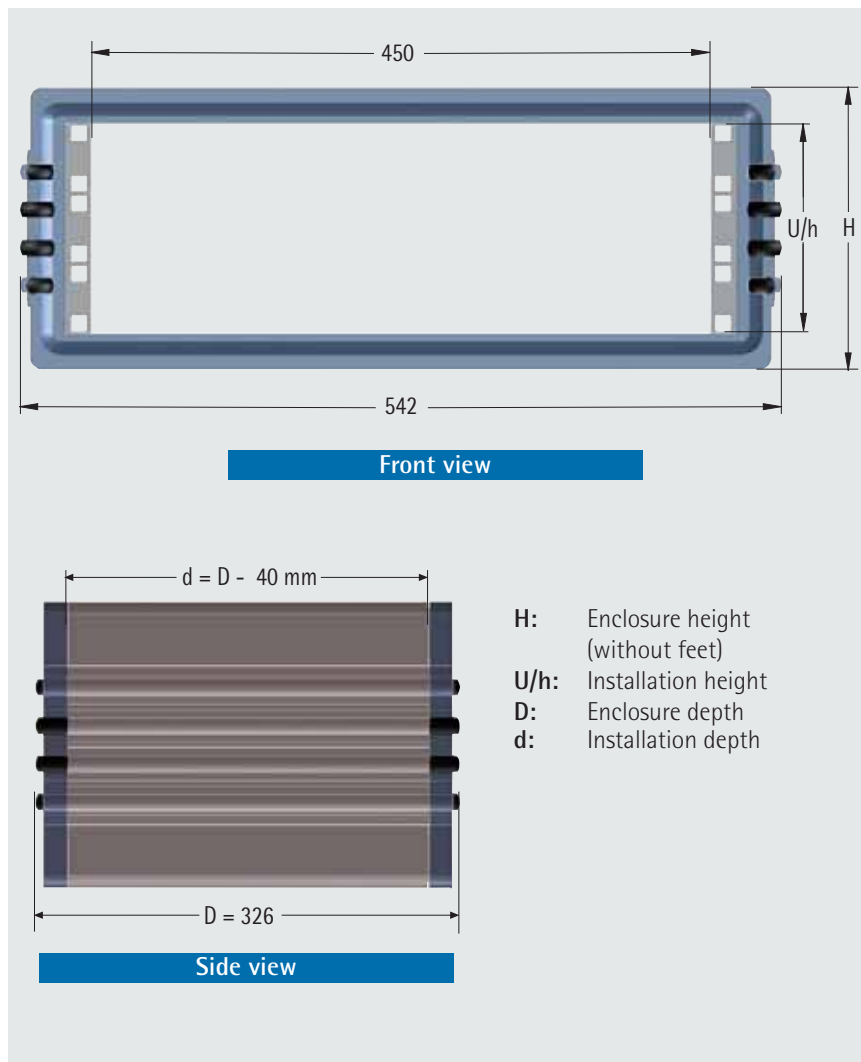

Order information

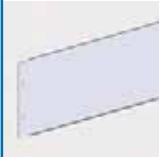
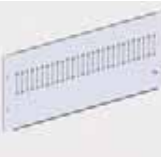
		19" enclosure solid	Rear panel solid	Rear panel ventilated	
Installation height	U				
	h mm	Enclosure height H mm			
3	132,5	179,5	18-5311-30	17-9203-47	17-9223-47
4	177	224	18-5411-30	17-9204-47	17-9224-47
6	266	313	18-5611-30	17-9206-47	17-9226-47

Other sizes on request!



Accessories

Prop-up and carrying handle



Hole pattern for mounting enclosure

- handle can be set in 30° steps by pressing a button to snap it into place

Load capacity: 50 kg

Finish:
Handle: RAL 9011 graphite black
Handle profile: anodised

Part no.
18-5100-84

Sliding rails

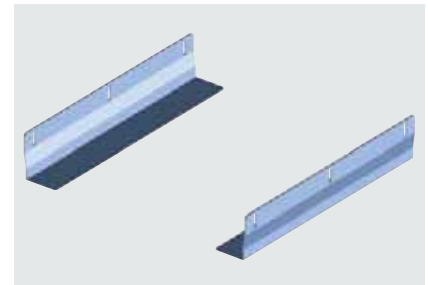

- assembly material included

Load capacity: approx. 20 kg
Material: sheet steel, galvanised

Part no. (pair)
18-5013-26

Screw set M 5 (50-fold)

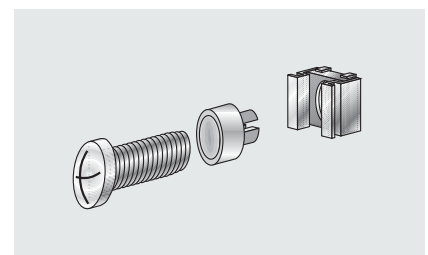

- 50 screws, M5 x 12
- 50 captive nuts, M5-8
- 50 decorative washers, M5 with collar

Part no. (set)
630-991

Trim pieces, clippable

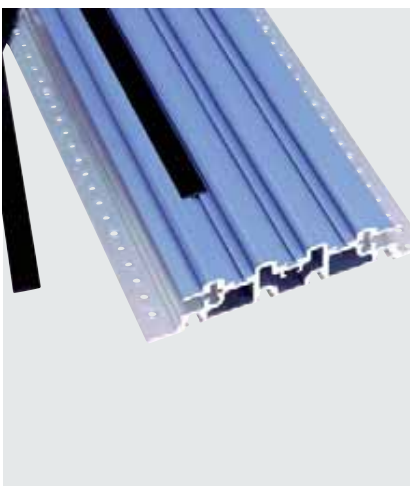

For installation height U	Necessary quantity*
3	6
4	10
6	18

*Note: for complete equipment

Finish:
black

Material:
plastic

Part no.
28-5010-02

Earthing kit



- for VDE-compliant earthing connection

For installation height U	Part no. (set)
3	28-5033-00
4	28-5034-00
6	28-5036-00